

# Honeywell



## Galaxy Dimension

User Guide



# Table of Contents

Introduction .....	vii
Compliance and Approvals .....	vii
<b>KEYPAD INFORMATION .....</b>	<b>1</b>
General .....	1
Mk7 LCD Keypad .....	1
Number Keys (0 – 9) .....	1
View Keys (A and B) .....	1
Enter Key (ent) .....	2
Escape Key (esc) .....	2
Hash Key (#) .....	2
Star Key (*) .....	2
Power LED .....	2
Banner .....	2
User Codes .....	2
TouchCenter .....	3
Self Diagnostics .....	3
Operation .....	3
<b>ACCESS CONTROL .....</b>	<b>4</b>
Access Control Card .....	4
Access Control Card - Batch Learn .....	4
<b>USER AND ACCESS TEMPLATES .....</b>	<b>4</b>
<b>SETTING THE SYSTEM .....</b>	<b>5</b>
Before Setting .....	5
Entering A Pin - User Type 2.1 - 2.2 .....	5
Entering A Pin - User Type 2.3 - 3.6 .....	5
Setting groups .....	5
Exit time .....	5
Sounder .....	6
Zones Open .....	6
Final Door/Terminator .....	6
System Set .....	6
Part Setting .....	6
Cancelling The Setting .....	6
Group Name .....	6
<b>MAX SETTING OPTIONS .....</b>	<b>7</b>
Setting with User Cards/Tags/Fobs .....	7
Dual Focus .....	7
Keyprox .....	7
<b>UNSETTING THE SYSTEM .....</b>	<b>8</b>
Normal Entry .....	8

Straying From the Entry Route .....	8
Slow Entry .....	8
Cancelling Alarms .....	8
Manager Reset .....	8
Engineer Reset .....	8
Unsetting with Proximity Cards .....	8
<b>Recording of Events .....</b>	<b>9</b>
<b>Fault and Tamper Conditions .....</b>	<b>9</b>
<b>Resetting Fault and Tamper Conditions .....</b>	<b>9</b>
<b>Overriding Fault and Tamper Conditions when Setting .....</b>	<b>9</b>
<b>MENU OPTIONS .....</b>	<b>10</b>
Full Menu .....	10
Quick Menu .....	10
Accessing The Menu .....	11
Full Menu .....	11
Quick Menu .....	11
Omit Zones (User Type 2.3 and Above) .....	12
<b>Purpose .....</b>	<b>12</b>
<b>Selecting Omit Zones .....</b>	<b>12</b>
<b>Viewing Eligible Zones .....</b>	<b>12</b>
<b>Omitting Zones .....</b>	<b>12</b>
<b>Setting With Omitted Zones .....</b>	<b>12</b>
<b>Vibration Zones .....</b>	<b>12</b>
<b>Atm 1/2/3/4 Zones .....</b>	<b>13</b>
<b>Forced Set (User Type 2.3 and Above) .....</b>	<b>13</b>
Purpose .....	13
Selecting Forced Set .....	13
Non-omittable Zones .....	13
<b>Chime (User Type 2.3 and Above) .....</b>	<b>14</b>
Purpose .....	14
Selecting Chime .....	14
Chime In Operation .....	14
<b>Display Zones (User Type 2.4 and Above) .....</b>	<b>14</b>
Purpose .....	14
Selecting Display Zones .....	14
Address .....	14
Function .....	14
Status .....	15
Description .....	15
Selecting And Viewing .....	15
Escape .....	15
<b>Display Log (User Type 2.4 and Above) .....</b>	<b>15</b>
Purpose .....	15
Selecting Display Log .....	15
Events .....	15
Selecting a Date .....	15

Viewing Each Event .....	15
Additional Information .....	16
Printing .....	16
<b>Print (User Type 2.4 and Above) .....</b>	<b>16</b>
Purpose .....	16
Selecting Print .....	16
Codes .....	16
Zones .....	16
Log .....	16
All .....	16
Help Message .....	16
<b>Walk Test (User Type 2.5 and Above) .....</b>	<b>17</b>
Purpose .....	17
Selecting Walk Test .....	17
All Zones .....	17
Selected Zones .....	17
Ending Walk Test .....	17
<b>Time/Date (User Type 3.6) .....</b>	<b>18</b>
Purpose .....	18
Selecting Time/Date .....	18
Changing Time .....	18
Changing Date .....	18
Advance and Retard .....	18
<b>Codes (User Type 2.1 and Above) .....</b>	<b>19</b>
Purpose .....	19
Manager Code .....	19
Selecting Codes .....	20
User Codes .....	20
Modify Pin .....	20
Modify Type .....	21
Modify Name .....	22
Time Zone .....	22
Schedule .....	22
Temporary Codes .....	23
Pin Change .....	23
Modify Groups .....	24
Card Number .....	25
Max Function .....	26
Max Keypad .....	26
Forgive Antipassback .....	26
Pin Warning .....	27
<b>Summer (User Type 3.6) .....</b>	<b>27</b>
<b>Trace (User Type 3.6) .....</b>	<b>28</b>
<b>Timer Control (User Type 3.6) .....</b>	<b>28</b>
<b>Group Omit (User Type 3.6) .....</b>	<b>32</b>
<b>Remote Access (User Type 3.6) .....</b>	<b>33</b>
<b>Access Authorization (User Type 3.6) .....</b>	<b>34</b>

<b>AVOIDING FALSE ALARMS</b> .....	<b>35</b>
<b>ZONE REFERENCE TABLES</b> .....	<b>36</b>
<b>ALARM AND HELP MESSAGES</b> .....	<b>37</b>
Alarm In Progress .....	37
Pa Reset Required .....	37
Manager Reset Required .....	37
Engineer Reset Required .....	37
Alarm Cause Code .....	37
No Entries .....	37
Invalid Selection .....	37
Invalid Code .....	37
Technistore Reset .....	37
No Modules Added .....	37
<b>INSTALLER DETAILS</b> .....	<b>38</b>

# INTRODUCTION

The Galaxy Dimension alarm system is a microprocessor controlled system which has been designed using the latest software and hardware technology.

First and foremost, the Galaxy Dimension meets all your security needs. The engineer will program and commission the system to your own exacting requirements.

## Warning:

There are no user serviceable parts inside. Please refer all servicing to a qualified installer.

## Compliance and Approvals

### Public Switched Telephone Network (PSTN) approval

The equipment has been approved to Council Decision 98/482/EC for Pan -European single terminal connection to the Public Switched Telephone Network (PSTN). However due to differences between the individual PSTNs provided in different countries the approval does not, of itself, give an unconditional assurance of successful operation on every PSTN network termination point.

In the event of problems contact the equipment supplier in the first instance.

The Galaxy is designed to interwork with the following networks:

Austria	France	Italy	Norway	Switzerland
Belgium	Greece	Liechtenstein	Portugal	United Kingdom
Denmark	Iceland	Luxembourg	Spain	* Germany
Finland	Ireland	The Netherlands	Sweden	

\* *May have interworking difficulties.*

**NOTE:** Contact the equipment supplier before using the Galaxy on any network not listed.







# KEYPAD INFORMATION

## General

The Galaxy Alarm system is controlled by the Galaxy Mk7 Full Alpha Liquid Crystal Display (LCD) keypad or the TouchCenter Graphics keypad.

## Mk7 LCD Keypad

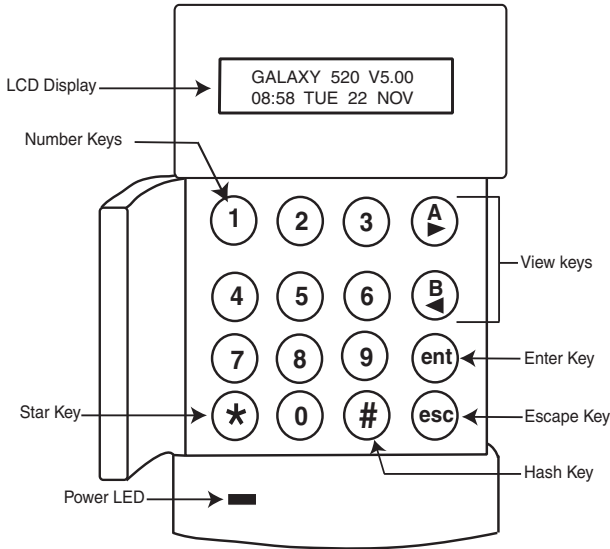

## Number Keys (0 – 9)

These keys are used to enter the code and to select and modify options.

Before carrying out operations on the system, users must identify themselves with a Personal Identification Number (PIN). This number is at least a 4 digit number selected from keys 0 - 9.

The number keys are also used where groups are programmed on the system permitting groups (areas) to be set or unset.

## View Keys (A and B)

These keys have been programmed to activate one of the system options. Pressing the **A >** key after a valid code has been entered starts the full set routine. Pressing the **B <** key after a valid code has been entered starts the part set routine.

Once a system option has been selected, the **A >** or **B <** keys can be used to operate as view keys, stepping forwards (**A >**) or backwards (**B <**) through lists of information. Holding down a view key while viewing an option list, rapidly displays each item in the list, permitting quick access to the information.

## Enter Key (ent)

The **ent** key accepts and processes entered data. Valid actions are performed and the next option is accessed.

## Escape Key (esc)

The **esc** key aborts the current option to return to the previous option level. Any option modification made prior to the option being aborted is erased. Successive pressing of the **esc** key returns the user to the start display (known as the BANNER).

The **esc** key also aborts the setting routine if pressed during the exit time.

## Hash Key (#)

The **#** key is used to display additional choices for certain options, e.g. ADVANCE/RETARD the time in the **Time/Date** option.

This key is also used as the user duress key (**by pressing twice following a valid code entry**).

## Star Key (\*)

The **\*** key is used to provide additional features for certain options, e.g. printing the event log or deleting entries.

## Power LED

The green power LED remains lit whenever the keypad is connected to a mains power supply. A mains power failure is indicated by the LED flashing slowly. The LED flashes rapidly if the battery voltage falls below the minimum threshold or if one of the fuses on the control panel PCB blows.

## Banner

The banner is the display shown on the keypad, e.g. **Galaxy 520 V5.00** (with the time and date on the bottom line). This is shown at all times when the system is unset, unless the menu is being accessed or an alarm or help message is on the display. The banner can be changed by the engineer. In the set condition the banner is normally blank.

## User Codes

The user code is a unique PIN (Personal Identification Number) of at least 5 digits in length. The PIN identifies the user to the Galaxy Alarm panel and allows operation of the system.

# TouchCenter

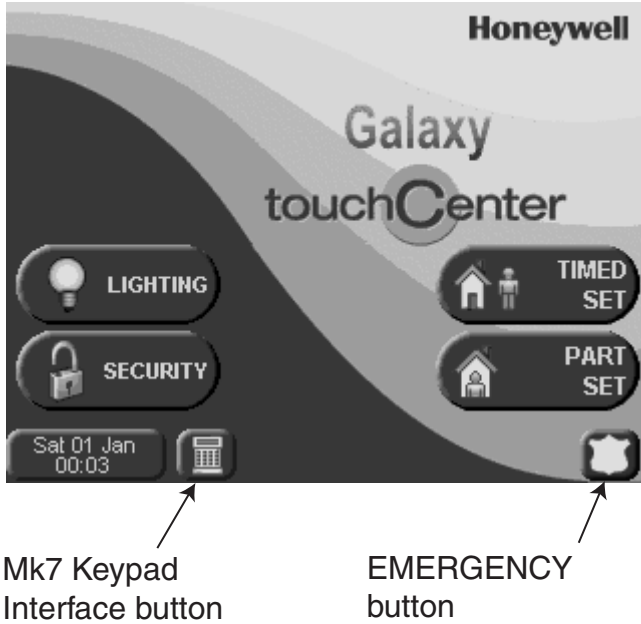

The TouchCenter is a touch-screen interface keypad with easy to learn on-screen instructions for use. The following features are available:

- Clear, easy to navigate menus.
- Clear text/icon based explanation of system events.
- Colour display.
- Touch screen.
- Help and guidance when faults and problems occur.

## Self Diagnostics

A series of diagnostic tests allows the user to verify correct operation of the TouchCenter and its connection to the Galaxy system. There are three diagnostic tests:

- LCD Display Test
- Audio Test
- LED Test

## Operation

The operation of the TouchCenter is explained in a separate TouchCenter Quick User Guide IG1-0803.

# ACCESS CONTROL

## Access Control Card

An access control card is a prox tag that can be presented to a proximity reader to:

- Allow access to access controlled doors
- Cancel alarms, faults or tampers
- To set or unset the system.

To assign a user an access control card:

- Access the menu option **42.1=User Codes**.
- Press the **A >** key to scroll to the correct user number and then press **ent**.
- Press **A >** until **07=Card No** is displayed on the keypad's LCD, then press **ent**.
- Key in the access control card's serial number, the \* (star key) can be used to erase the last digit keyed in.
- Press **ent** to store the serial number.
- Press **esc** to return to the banner.

## Access Control Card - Batch Learn

The batch learn function allows one or more access control cards to be assigned to users. This is achieved using a specific proximity reader which is assigned when the system is installed.

To enter and use the batch learn function:

- 1 Access the menu option **42.3.4=Batch Start**.
- 2 Key in the first user number to be assigned an access control card.
- 3 Press **ent**.
- 4 Access the menu option **42.3.1=Add Batch**.
- 5 At the proximity reader present the first access control card to be assigned.
- 6 That access control card will be assigned to the displayed user and then the keypad's LCD will move on to the next user.
- 7 Repeat steps 5 thru 6 to assign multiple access control cards.
- 8 Press **esc** to finish and return to the banner.

# USER AND ACCESS TEMPLATES

Every user on the system can be allocated an access template. An access template is a list of **groups** and **time schedules** that will dictate which groups a user is able to gain access to and also the times that the user can gain access. This method means that if there are multiple doors leading into one group or area, then a user will be given access to all those doors in one move. This reduces programming time and complexity.





# MAX SETTING OPTIONS

## Setting with User Cards/Tags/Fobs

Proximity user cards/tags/fobs can be used to set the system. This is done by assigning a user with one of the setting options. When the card is held against a MAX module or keyprox for five seconds, the card-held function assigned to the card user is activated. For example, if the MAX function assigned is **13 = Part Set**, then activating the card held function results in the system being part set. For access control readers, a function button or triple swipe is required to activate the card function.

If a user is assigned group choice, then a keypad will have to be accessed to select the group for setting after swiping the card.

## Dual Focus

If a # is assigned to a particular users pin and their max card number, then the user will have dual focus operation. This means that they will have to enter their pin first, before setting with the max card and vice versa.

## Keyprox

A keyprox is a keypad that has a card reader built in. They are normally installed on systems where dual focus setting and unsetting are used. Keyproxes are used as a keypad and MAX as detailed above, but the card is held against the lower right corner of the keypad as shown in the following diagram:

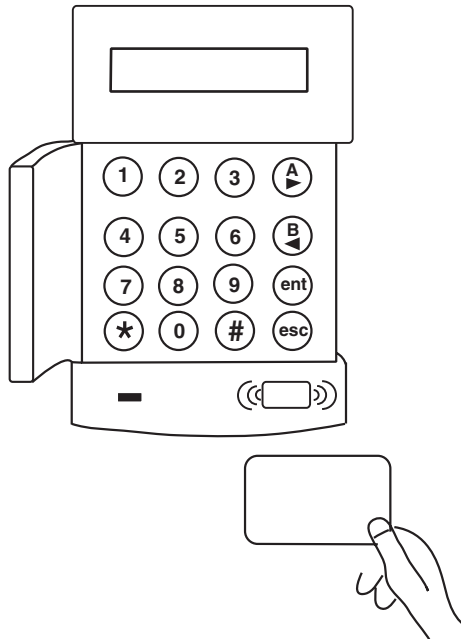

# UNSETTING THE SYSTEM

## Normal Entry

Unsetting starts immediately when the **FINAL** door is opened or an **ENTRY** zone is activated. The sounder pulses slowly and the user must go directly to the keyprox and present a valid keytag or card to the prox reader to unset the system.

If using a keypad enter a valid PIN, followed by **A>**, **<B** or **ent**.

Users with group choice, will access the UNSET screen following PIN entry. This permits the user to unset specific groups. To return to the SET screen press **ent**.

## Straying From the Entry Route

Go directly to the keypad when entering the building. If the user strays into a protected area and activates a zone, an alarm will occur. The police may be called out and the system will have to be reset.

## Slow Entry

Enter a valid PIN before the entry time expires. If the entry time expires before a valid PIN is entered, then an alarm will occur. The sounder begins to pulse quickly when 75% of the entry time has elapsed indicating time is running short.

## Cancelling Alarms

To cancel an alarm, enter a valid PIN followed by **ent** at the keypad. The keypad displays details of the zone activated. When more than one zone is activated, details can be viewed using **A >** or **< B**. Press **ent** to return to the banner. Certain types of alarms, once cancelled, require a code with the appropriate reset authorisation to be entered. The system prompts for a valid reset code by displaying **Manager Reset Required** or **Engineer Reset Required** on the keypad.

### Manager Reset

Entering a manager type PIN followed by **ent**, resets the system following an alarm activation.

### Engineer Reset

Certain types of alarm require an engineer to visit the site and, after investigation, reset the system. In such cases, the system cannot be reset until the engineer reset has been carried out.

## Unsetting with Proximity Cards

If any of the groups assigned to the card are set, then swiping the MAX, keyprox or access control reader with a card unsets the groups. Group choice and dual focus operation, where implemented will apply as per setting instructions.

PIN + ent

Galaxy 520 V5.00  
15.49 MON 18 Nov

PIN + ent

4 ALARMS  
[<] [>] to View

CALL MANAGER  
RESET REQUIRED

CALL ENGINEER  
RESET REQUIRED



# Recording of Events

During any given set period, there is no limit to the number of signals sent from individual activations. However, no more than three events from any single source will be recorded in the event log.

# Fault and Tamper Conditions

When a fault or tamper condition occurs in the unset state, an alert condition is activated. This consists of an intermittent beep at the keypad and/or a visual alert on the keypad. A user should enter their code at the keypad and press **ent**. The condition causing the fault or tamper will be shown. Use the A>and <B keys to scroll through multiple faults.

When a fault or tamper condition occurs in the set state, the condition will be displayed on the keypad when a user unsets the system.

# Resetting Fault and Tamper Conditions

When an alarm, fault or tamper condition is generated on the system, a reset must be carried out before normal system operation can resume. Fault and tamper conditions can be reset provided:

1. The cause has cleared.
2. An authorised PIN or anti-code has been entered
3. The conditions have been viewed, by a user, on the keypad display after steps 1 and 2 above.

If a user does not have sufficient authority to reset the condition, a temporary banner is displayed to indicate that a manager or engineer is required to reset the condition.

On a system installed to meet EN50131 Grade 3, most fault and tamper conditions will require an engineer level PIN to reset. Alternatively, an Anti code given by the alarm monitoring centre may be used reset the system, depending in the cause and the configuration of the system.

# Overriding Fault and Tamper Conditions when Setting

If it has not been possible to reset the system due to and outstanding fault or tamper condition, it may be possible to override the condition and set the system anyway. This depends on the authority of the user and the type of outstanding condition.

Any outstanding conditions will be displayed whenever setting is attempted and the setting procedure will be halted. However, if the condition can be overridden by the user, the message **ent=CONTINUE SET** will be displayed. Pressing **ent** at this point will override the condition for one set period only, and log the override action against that user. The condition will return when the system is next unset.

# MENU OPTIONS

The Galaxy Dimension provides various menu options for modifying the functional performance of the system.

There are two menu structures:

## Full Menu

Only accessed by authorised users including the master manager code and by the engineer.

## Quick Menu

A selection of options from the full menu. The quick menu is the default menu access for all user codes (type 2.3 and above) except the master manager and engineer. If the user is not permitted to enter a menu option then the message **Invalid Option** appears on the display.

User Type	Quick Menu	Full Menu			
		Type 2.3	Type 2.4	Type 2.5	Type 3.6
2.3	0 = Omit Zones	10 = Setting	20 = Display	30 = Test	40 = Modify
2.3	1 = Forced Set	11 = Omit Zones	21 = Display Zones	31 = Walk Test	41 = Time/Date
2.3	2 = Chime	12 = Timed Set	22 = Display Log	32 = Outputs	42 = Codes
2.4	3 = Display Zones	13 = Part Set	23 = System		43 = Summer
2.4	4 = Display Log	14 = Forced Set	24 = Print		44 = Trace
2.4	5 = Print	15 = Chime	25 = Access Doors		45 = Timer Control
2.5	6 = Walk Test	16 = Instant Set			46 = Group Omit
3.6	7 = Time/Date	17 = Silent Part			47 = Remote Access
2.1	8 = Codes	18 = Home Set			48 = Access Authorization
3.6	9 = Summer	19 = All set			

Table 1. Menu Options

## Accessing The Menu

To access the menu enter a valid code and press the **ent** key. If there are any outstanding system faults, these will be displayed first. Where there is more than one fault a > symbol will be displayed and the scroll keys can be used to view them. Pressing the **ent** key again takes the display into the menu. The Full Menu or Quick Menu is accessed, depending on the user type.

- Note:**
1. If the user does not have group choice, all groups assigned to the user code must be unset.
  2. If the user has group choice, only the group that the FINAL or ENTRY zone is assigned to in unset.
  3. If there are no groups, then the system must be unset.

## Full Menu

The Full Menu has a hierarchy of four structures contained within it. Each structure is accessible by an increased user code type.

## Quick Menu

The Quick Menu offers users type 2.3 and above a selection of up to 10 options, numbered 0 – 9. The required option is selected by entering the option number (0 – 9) or by using the **A** > or < **B** keys to display each option.

The menu options (as with all Galaxy lists) are circular, therefore menu option 9 is followed by menu option 0.

**NOTE:** User Type 2.1 only has access to the **8 = Codes** menu to permit a PIN change.

The following Quick Menu options are the factory default settings. Each option is described in the following pages.

# Omit Zones (User Type 2.3 and Above)

## Purpose

This option allows the user to omit zones before setting the system. Zones must be eligible for omission otherwise they will not be displayed.

**Note:** Zones remain omitted for one set period only.

## Selecting Omit Zones

Enter the QUICK MENU. The 0=OMIT ZONES option is displayed. Press the **ent** key to select this option.

## Viewing Eligible Zones

When the **Omit Zones** option is selected the first zone eligible for omission is displayed. The eligible zones can be viewed by pressing the **A>** or **<B** keys. The zones eligible for omission can be rapidly viewed by holding down either of these keys.

## Omitting Zones

Once the zone to be omitted is shown on the display, press the **#** key. The display indicates that the zone is omitted. **A>** and **<B** keys can then be used to select other zones to be omitted using the same method.

**Note:** A zone is omitted from the system as soon as the **#** key is pressed. The system does not have to be set.

## Setting With Omitted Zones

When the list of omitted zones is complete the setting routine is started by pressing the **ent** key. The system starts to set and the display indicates how many zones have been omitted. Alternatively the **esc** key can be used to return to the menu options. Zones that have been omitted remain omitted even after using the **esc** key.

**Note:** All zones omitted are recorded in the log against the user.

## Vibration Zones

If the omitted zone is a vibration zone, then all zones of this type (in all groups) will be block omitted. The vibration zones remain omitted until manually reinstated. Unsetting the system does not reinstate vibration detectors.

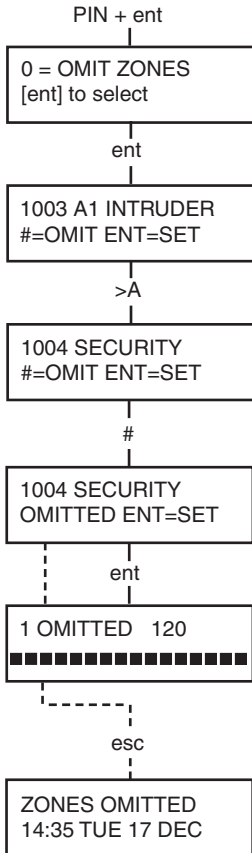



## Chime (User Type 2.3 and Above)

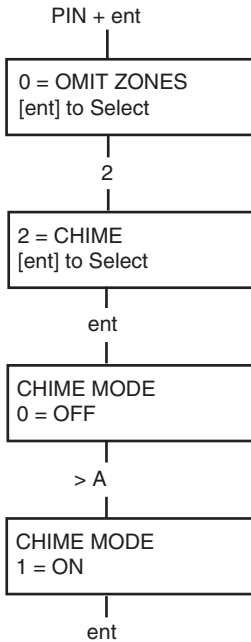

### Purpose

The **Chime** mode is switched on and off by this option. When the **Chime** mode is on, any zones that have been programmed by the engineer for chime will activate momentarily when opened.

**Note:** Your system may not require any zones of this type.

### Selecting Chime

Enter the QUICK MENU. Press key **2** followed by the **ent** key. The display shows the ON/OFF status of the **Chime** mode. Press the **>A** key to toggle between the states and press the **ent** key to accept the selection.

**Note:** Keys **1** AND **0** can also be used to select ON and OFF respectively.

### Chime In Operation

When switched ON, the **Chime** mode remains active until switched OFF again. Zones that have been programmed with the chime attribute by the engineer continue to chime when they are activated.

**Note:** The **Chime** mode is suspended while the system is set or during an alarm.

## Display Zones (User Type 2.4 and Above)

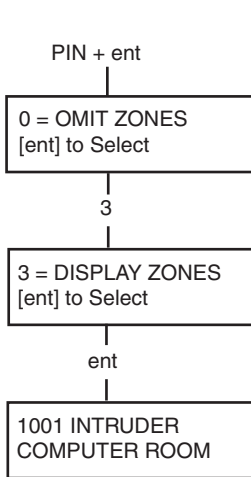

### Purpose

This menu option provides the user with a method of accessing the **Display Zones** mode and checking each zone for its description and current status.

### Selecting Display Zones

Enter the QUICK MENU. Press key **3** followed by the **ent** key. Details of the first zone (1001) are displayed.

### Address

The zone address provides a unique four digit address number used for identification and selection, e.g. 1026 - line 1, RIO 02, zone 6.

### Function

The zone function is displayed and identifies the operation of the zone, e.g. INTRUDER, FIRE.

## Status

The current status of the zone is displayed as circuit information, e.g. Open or Closed. This information alternates with function information.

## Description

The zone description, if programmed, is displayed on the bottom line of the display. The descriptor is assembled from alpha-numeric text and describes the zone in detail, e.g. West Office Door.

```
1001 INTRUDER
COMPUTER ROOM
```

2+1

```
1021 SECURITY
CASHIER DOOR
```

esc

## Selecting And Viewing

Selecting the **Display Zones** option displays the first zone address available on the system. Other zones can be viewed sequentially by using the **>A** or **<B** keys. Zones can also be displayed by entering the address of the zone: enter the line, RIO and zone number (4 digits). Press the **#** key to display the circuit resistance in ohms and RIO voltage (if hardwired).

## Escape

The **esc** key aborts the option and returns to the option menu.

## Display Log (User Type 2.4 and Above)

PIN + ent

```
0 = OMIT ZONES
[ent] to Select
```

4

```
4 = DISPLAY LOG
[ent] to Select
```

ent

```
LOG      A12345678
Groups   NN-----
```

1 + 2

```
LOG      A12345678
Groups   YY-----
```

ent

```
08:53 TUE 22 NOV
AC FAIL-RIO108
```

B (hold)

```
MON 21 NOV 1999
```

```
MON 20 NOV 1999
```

release B

## Purpose

The **Display Log** option provides the user with a means of viewing the system history. Events are recorded in detail and stored in the non-volatile memory.

## Selecting Display Log

Enter the QUICK MENU. Press key **4** followed by the **ent** key. Details of the most recent event to be logged are displayed.

## Events

The events available for display include details of setting, unsetting and alarms. Each event is timed and date stamped.

## Selecting a Date

Hold down one of the view keys, the dates held in the log are rapidly stepped through. The **A>** key moves forward through the dates and the **<B** moves backwards. Stopping at the required date reveals the first event for that date.

## Viewing Each Event

The entire events of any one date can be viewed by progressively stepping through the events using the **A>** and **<B** view keys. \*

If the user has group choice enabled, the groups will display. Events for each group can be displayed by entering the group number.

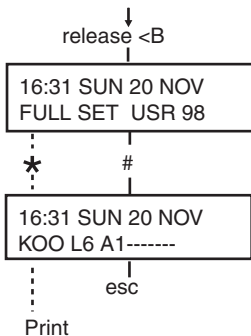

### Additional Information

The # key can be used to reveal additional information on some types of events. This information is displayed on the bottom line. The information includes details such as zone descriptors, user types and which keypad was used.

### Printing

If a serial printer is connected to the system, a system history can be printed by pressing the \* key. The system will print from the event on display until the most recent event.

## Print (User Type 2.4 and Above)

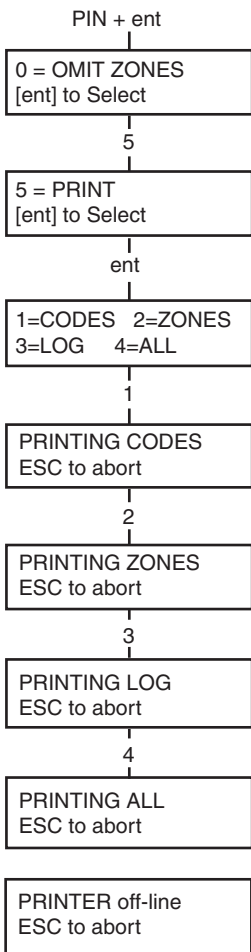

### Purpose

The **Print** option gives the user the opportunity to get a hard copy print-out of the system details. This option requires a serial printer to be connected to the system.

### Selecting Print

Enter the QUICK MENU. Press key **5** followed by the **ent** key. The system print options are displayed. Pressing the **esc** key aborts the PRINT option.

### Codes

Press key **1** to start the print-out of all the codes, giving the user number, name, level and length of code.

### Zones

Select the **Zones** option to print-out the details of each zone in the system. The zone address, function, and descriptor is printed. Press key **2** to select this option.

### Log

The entire LOG can be printed out by selecting key **3**. The print-out consists of up to 1000 events depending on panel type, and details the time and date of setting, unsetting and alarms.

### All

All the options (CODES , ZONES, and LOG) can be printed out by selecting the **ALL** option. Pressing key **4** delivers a print-out starting with user codes.

### Help Message

If a print-out is started without a printer being connected and on-line, the display indicates that the printer is off-line.



# Walk Test (User Type 2.5 and Above)

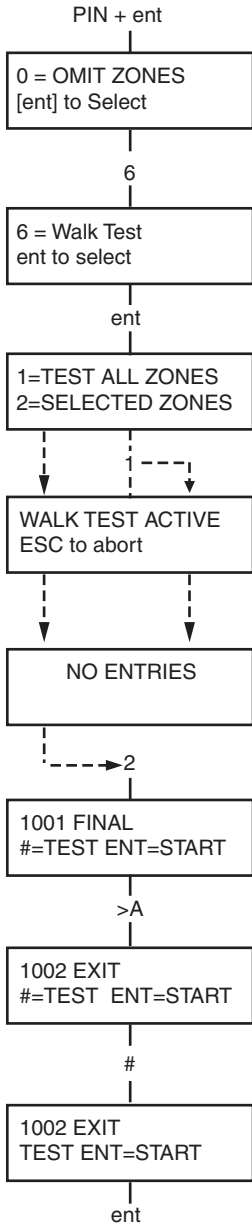

## Purpose

The **Walk Test** option provides a method of testing the zones to ensure that they are operating correctly. There are two options available:

1. All zones can be tested
2. Selected zones can be tested

In both cases the sounder (if Audible Walk Test is selected) indicates an open zone. The test is recorded in the log. Wire-free zones also show the received signal strength as a percentage

## Selecting Walk Test

Enter the QUICK MENU. Press the key **6** followed by the **ent** key. When **Walk Test** is selected, the options are **1=View** or **2 = Activate**.

If **1=View** is selected the user can view **Untested** zones or **Tested** zones. If **2=Activate** is selected then a further choice of a **Silent** or **Audible** Walk Test is available. The choice between **Test All Zones** or **Selected Zones** displays in both cases.

## All Zones

Choosing **All Zones** (press key **1**) starts the test immediately. No selection is necessary as all valid zones are included in the test. The sounder operates whenever a zone is opened and stops when all zones are closed.

**Note:** The **Test All Zones** option only tests zones which can be omitted from the system.

## Selected Zones

Choosing the **Selected Zones** option by pressing key **2** displays the first zone on the system. Each zone is displayed in turn by using the **>A** or **<B** keys. When the zone to be included in the test is displayed, press the **#** key. Other zones can be included in the test in the same manner. When all of the required zones have been selected, press the **ent** key to start the **Walk Test**.

**Note:** The **Selected Zones** option includes non-omittable zones.

## Ending Walk Test

To abort the walk test option press the **esc** key, otherwise the walk test option remains active for 20 minutes after the last key press.

## Time/Date (User Type 3.6)

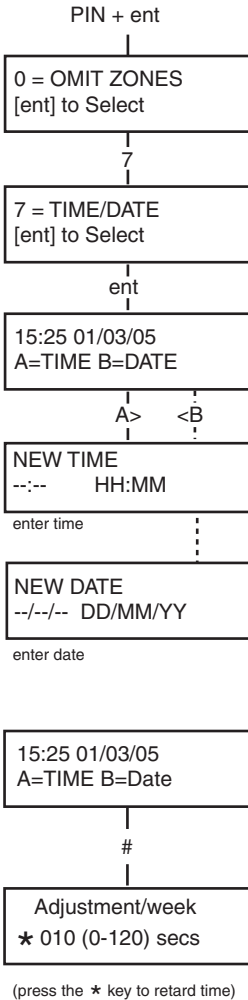

### Purpose

The **Time/Date** option allows the user to modify both the time (hours/minutes) and the date (day/month/year).

### Selecting Time/Date

Enter the QUICK MENU. Press key 7 followed by the **ent** key. Once the **Time/Date** option has been selected, the time or date can be selected by pressing the **A>** or **<B** key.

### Changing Time

To change the time press the **A>** key. The display prompts for a **New Time** in hours and minutes (HH:MM). When the new time is entered, the display immediately returns to the time or date selection screen. The system does not accept invalid times (greater than 23 hours, greater than 59 minutes). Pressing the **esc** key aborts the entry.

### Changing Date

To change the date press the **<B** key. The display prompts for a **New Date** in days, months and years (DD/MM/YY). When the new date is entered, the display momentarily shows the day of the week, before returning to the time or date selection screen. The system does not accept invalid dates (e.g. **32/13/99**). Pressing the **esc** key aborts the entry.

### Advance and Retard

It is possible to advance and retard the time to compensate for any variations in clock speed. Press the **#** key when in the time/date mode to select the clock speed adjustment. The range is 0 to 120 seconds per week. Pressing the **\*** key will retard the time.

## Codes (User Type 2.1 and Above)

Each PIN user has access to modify their own PIN. Users do not have access to user codes other than their own. The only exception to this is the manager code.

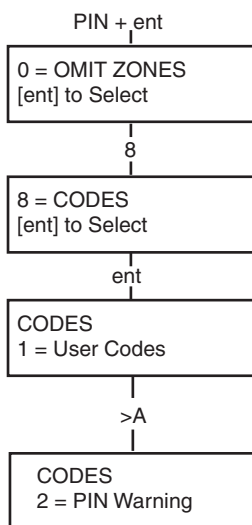

### Purpose

The **Codes** menu option enables the managers, (user type 3.6), to assign, modify and delete the codes that allow users to operate and access the system. The codes option is divided into two sub-menus:

#### 1. User Codes

Sub divided into 10 menus (depending on whether the group and **MAX Mode** options are enabled) that determine all of the access information for users with Personal Identification Numbers (PINs). This menu also assigns MAX details to user numbers.

#### 2. Pin Warning

This option determines the warning period given to users prior to the programmed **Pin Change** date.

**Note:** The valid period for **Pin Change** codes is programmed by the installation engineer.

### Manager Code

The manager code is authorised to:

- Program the USER CODES option for each of the user codes.
- Allocate other codes to manager type 3.6.
- Modify the manager PIN (the manager PIN cannot be deleted)
- Assign the MAX features to the code.

The manager code defaults to group choice when groups are enabled. The manager is able to toggle the group choice option on and off (using the \* key) as required.

The manager code defaults to accessing the quick menu.

**Note:** The MAX is the Proximity Access Reader which can be connected to the Galaxy system. This also refers to the MAX<sup>3</sup>, the enhanced version of the MAX.

Galaxy	No. of Codes	Manager	
		Default PIN	User No.
GD-48	100	12345	98
GD-96	250	12345	248
GD-264	1000	12345	998
GD-520	1000	12345	998

**Table 2. Default Codes**

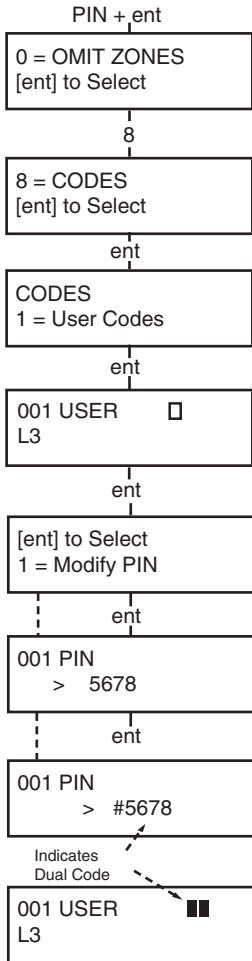

## Selecting Codes

Enter the QUICK MENU. Press key **8** followed by the **ent** key.

## User Codes

When the **Codes** option has been selected, press key **1** to access **User Codes**. Display each of the user numbers using key **A>**. Each user number offers options for PIN, level, name and where applicable time zones and groups. When the user number to be modified is displayed, press the **ent** key to access the **Modify Pin** option.

## Modify Pin

The **Modify Pin** option allows a pin to be assigned to a user or an existing PIN to be modified. The PIN must be a four, five or six digit number that is unique to the system. If a duplicate PIN is assigned, the message **Duplicate Entry** is displayed. As each digit is entered it appears on the bottom line of the display. Pressing the \* key erases the last digit displayed. Continued pressing of the \*key will erase all of the digits. When the correct PIN has been assigned press the **ent** key to accept the programming and return to the previous menu level.

When a PIN has been assigned to a user number, a solid box (■) is displayed on the line of the user number details screen.

### • Deleting a Pin

Existing PIN entries can be completely erased using the \* key instead of a digit entry. When there is no PIN assigned to a user number a hollow square (□) is displayed in the top line of the users details screen.

### • Assigning Dual Codes

To program a user code as a **Dual Code** press the # key while the **Modify PIN** option is selected. The # displays at the start of the assigned user PIN e.g. **#5678**. When a PIN has been assigned as a dual code two solid boxes (■■) are displayed in the top line of the users details screen.

### • Dual Codes Operation

Entry of a single dual code cannot gain access to the menu, set or unset the system. The message **NO ACCESS – ADDITIONAL CODE** is displayed. A second dual code must be entered within 60 seconds to access the menu, set or unset the system. Dual codes can be of different levels. The highest level code entered determines the access level to the system.

A single entry of a dual code, without a second dual code entry within 60 seconds, results in an **Illegal Code** record in the EventLog. All outputs programmed as **Illegal Code** are activated.

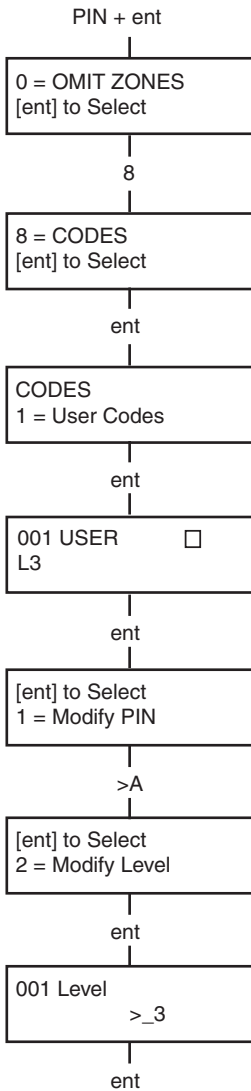

## Modify Type

Each user is assigned an access type which determines the menu options available to the user (see Table 1. Menu Options). On selecting this option, enter the type to be assigned to the user and press the **ent** key to accept the programming and return to the previous menu level. See Table 3. User Access Levels, for access availability.

EN50131-1 Level	Level		Access Availability
1	1.0†	Guard	Entered into event memory – no other option
2	2.1†	Cleaner	Can only set the system
2	2.2†	Caretaker	Can only set and unset the system
2	2.3	Users	Menu options 11 - 19
2	2.4	Users	Menu options 11 - 25
2	2.5	Users	Menu options 11 - 32
2	3.6‡	Manager	Menu options 11 - 48
3	3.7‡	Engineer	Menu options 11 - 71
3	3.8‡	Remote	Menu options 11 - 71
† No access to menu functions ‡ The manager, engineer and remote codes (the last three codes on the system) have fixed types which cannot be reprogrammed.			

**Table 3. User Access Levels**

### • Duress Code

If the # key is pressed while **Modify Level** is accessed, then the current code is assigned as a Duress Code. There is no limit to the number of codes which can be assigned as Duress. Entering a duress code at any time activates outputs programmed as **Duress or PA**.

Any valid PIN followed by ## **ent** (the **ent** key can be replaced by either the **A>** or **<B** key) can be used as a Duress Code. This is disabled in the UK to comply with regulations.

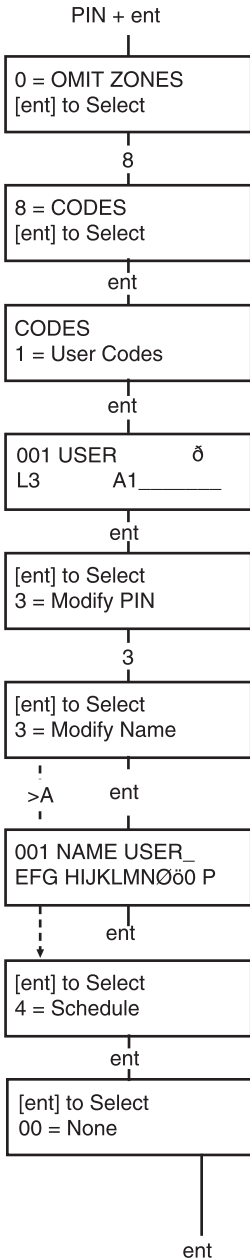

### • Quick Menu

All user codes default to the quick menu. This menu is made up of a selection of ten options (0 – 9) from the menu options 11 – 49. The user code type controls access to the quick menu. Any user can be upgraded from the quick menu to the full menu by assigning a \* to the user while the **Modify Level** option is accessed. Therefore a user with a type \*2.5 would have access to the full menu from options 11 – 32. No code can access both menus.

**Note:** The master manager code defaults to the full menu.

### Modify Name

This allows a name to be assigned to the user (maximum 6 characters). Each of the user codes default to the name **USER** and the manager defaults to **MGR**. The manager name cannot be changed. On selecting the **Modify Name** option, a section of the alpha-numeric that can be assigned to the user name is displayed on the bottom line of the keypad; the cursor flashes on the letter **L**. Press \* to erase the letters of the default or previous name. When the previous name has been erased, use the **A>** or **<B** keys to move the cursor to the first letter of the name and press the **ent** key. The selected character appears on the top line, continue this process until the name is completed. The # key toggles between upper and lower case characters and the system library. Press **esc** to save the name and exit.

### Time Zone

Managers can allocate time zones to user PINs when **TIMERS** have been programmed by the engineer. Time zones are used to disable the user PIN during the times (**ON to OFF**) programmed in **TIMER A** and **B**.

### Schedule

This option allows the user's pin code access to the panel menu options for setting and unsetting. The pin code only operates during the OFF period of an assigned weekly schedule.

If a user attempts to use his pin code during the **ON** periods of his assigned schedule, then an illegal code event is logged and any outputs programmed as illegal code are activated.

Setting this option to **00=None** means that pin codes are always operational.

**NOTE:** This option **does not** control card access through doors at all. This is controlled by templates and is allocated to a user in option **42.11=Template**.

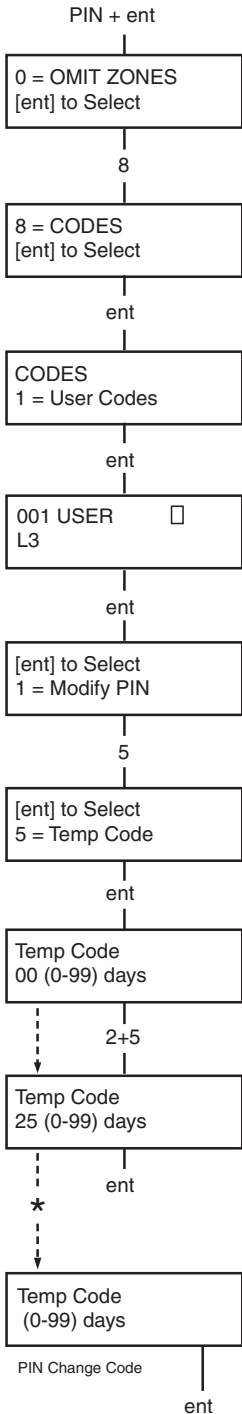

## Temporary Codes

**Temporary Codes** allow a PIN to be temporarily allocated to a user. On selecting this option, enter the number of days (0 – 99) that the code is to remain active. The default setting of **0** indicates that the code is permanent. A temporary code expires and is removed from the codes list at midnight after the assigned number of days. A code that has been assigned as a **Temporary Code** is indicated on the user code display by a ^ between the user number and the user name, e.g. **001^ USER**.

**Note:** The manager, engineer or remote codes cannot be assigned as a **Temporary Code**.

## Pin Change

To program a user code as a **PIN Change** code, select the **Temporary Codes** option and press the \* key instead of a number of days for a temporary code. Press the **ent** key to accept the programming and return to the previous menu level. A code assigned as a **PIN Change** code is indicated on the user code display by a \* between the user number and the user name, e.g. **001 \* USER**. If a user is assigned the **PIN Change** feature in the **Temporary Code** option, the user must assign a new PIN after a predetermined period of time otherwise the PIN expires and is no longer operational. A notification (1 – 28 days) that the PIN requires to be changed can be assigned using the **PIN Warning** option. This prompts the user to assign a new code whenever the expiring code is entered during the PIN Warning period (except during system unsetting). The new PIN must be four to six digits long and must be different from any current PIN. The new PIN must be re-entered and if confirmed, returns the user to the banner. If the **esc** key is pressed or the new PIN entered is invalid, the user may continue to use the panel as normal. The next PIN entry will prompt the PIN change.

**Note:** If the user has not entered a new PIN by the end of the PIN Warning period, then the PIN is erased on the next unsetting of the system.

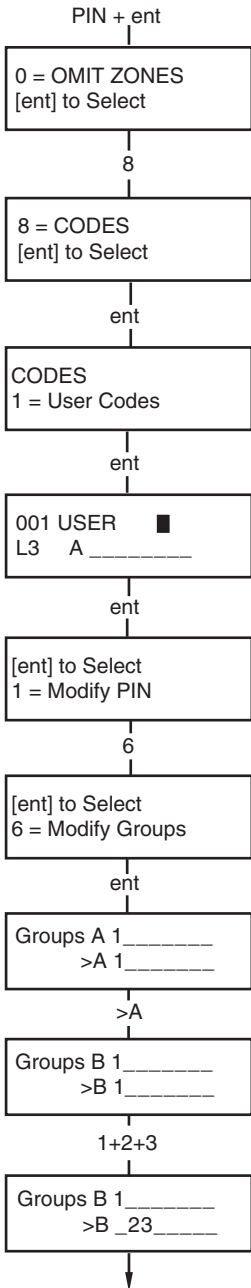

## Modify Groups

This option determines the system groups that the user has access to and operational control over. The **Modify Groups** option is only available when the **Group Mode** has been enabled by the engineer. The system defaults to groups disabled.

Groups allocated to the user are displayed when the **Modify Groups** option is selected. All users default to Group 1. Pressing the group number toggles the group assigned to the user. e.g. Pressing **2** and **3** assigns Groups 2 and 3 to the user. Pressing **1** (while group 1 is already assigned) removes group 1 from the user code. To assign group choice to the user, press the \* key. When the required groups have been assigned to the user, press the **ent** key to accept the programming and return to the previous menu level.

### • Multiple Group systems

The larger Galaxy systems have more than 8 groups. The groups are displayed on the keypad in blocks of eight groups which are labelled A, B, C and D:

Use **A>** or **<B** keys to move between the group blocks. Press keys 1 – 8 to assign the groups in each block to the user.

Group Block	Physical Groups
A1-8	1-8
B1-8	9-16
C1-8	17-24
D1-8	25-32

### • Single Groups

A user can be assigned to any single group. In this case a user can only access, set and unset the single group.

### • Multiple Groups

Users can be allocated to more than one group in which case access and operation are collective. The user cannot choose to operate on a single or combination of the assigned groups.



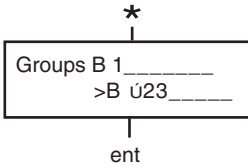

### • Group Choice

Users can be allocated to more than one group, but also have the choice of which of the allocated groups to view, set or unset. Pressing \* key while assigning groups to the user assigns the group choice feature.

- Notes:**
1. The manager has fixed access to all system groups. This cannot be reprogrammed.
  2. The manager is assigned group choice by default, but the feature can be removed.
  3. Users authorised to access the **Codes** option can only assign groups that have been assigned to their user code. A user who does not have access to group 4, cannot assign group 4 to another user code.

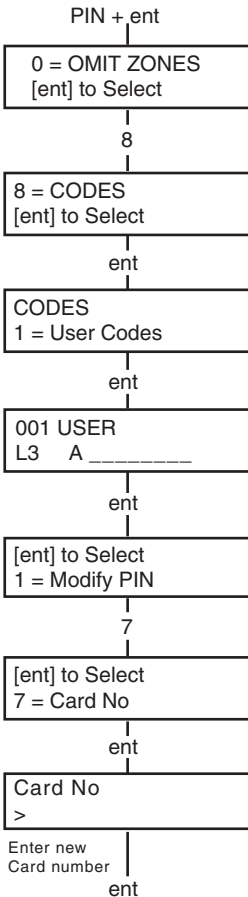

### Card Number

Each access card/tag/fob has a unique 10 digit number laser etched onto it. A card/tag/fob is assigned to a user by entering this number in the **Card No** option. The number identifies the card/tag/fob to the system and references it to the user it has been assigned to.

1. Enter the unique 10 digit number which is laser etched onto the card **or** enter the unique RF keyfob button identifier generated by the RF RIO **or** press the **A** and **1** keys simultaneously of the KeyProx and present the card/fob to the KeyProx reader within 5 seconds. The decrypted number in the card will be self learned onto the Galaxy panel and is displayed on the KeyProx..

2. Press the **ent** key to save the programming and return to the previous menu.

**Note:** A card number can be assigned to a user code that does not have a PIN allocated to it. All other options for this user are valid for the card/tag/fob.

When a card number has been assigned to a user number, a lower case (m) is displayed on the top line of the user number details screen.

A # assigned to the max number makes the max function dual focus, ie it needs the pin entered first. A star \* assigned to the max number makes the card dual access, ie it needs another card to open doors.

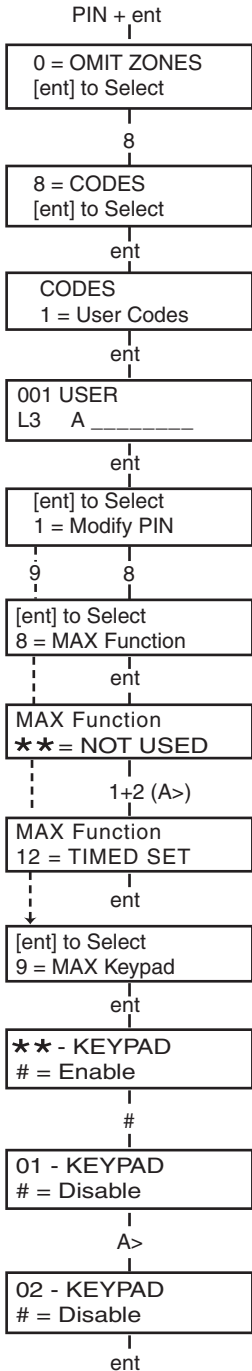

## Max Function

The MAX card can be assigned to a single menu option. The user must be authorised to access the menu option, either by the user level assigned or by having the menu option access type changed by the engineer.

The default option is **Not Used**. A new option is assigned by scrolling using the **A>** or **<B** keys until the required option is displayed or directly entering the option number using the keypad digits. Select the function by pressing the **ent** key

## Max Keypad

The menu option assigned to the MAX card/tag/fob can be limited to operate on a single keypad. On selecting this option the display shows \*\*, indicating that a keypad has not been specified. To specify a keypad, press the # key. The address of the first keypad on the system is displayed. Use the **A>** or **<B** key to select the required keypad and press the **ent** key to accept the programming.

**Note:** A black flashing square over the first digit of the keypad address indicates the address of the keypad currently being used.

### • “Card- Held” Max Operation

The MAX function is activated when the card is held directly in front of a MAX reader for three seconds. The MAX reader must be assigned a common group to the MAX user. The keypad specified in the **Max Keypad** option displays the assigned MAX function.

**Note:** If the specified keypad is in use, then the option does not display. If the MAX function is an “action” type option, e.g. **12 = Timed Set**, then the function is carried out.

If no keypad is specified (\*\*), the MAX menu option will operate on all keypads that share the groups of the MAX user. If there is more than one keypad, the message **Press any key** is displayed on all valid keypads. Press any key to activate the function on that keypad. Press no key within five seconds and the function automatically activates on all keypads.

## Forgive Antipassback

When the Timed Antipassback feature is enabled, it will prevent more than one use of any particular card at a particular reader within a preset time period. The forgive function is available to clear all or particular antipassback restrictions in force.

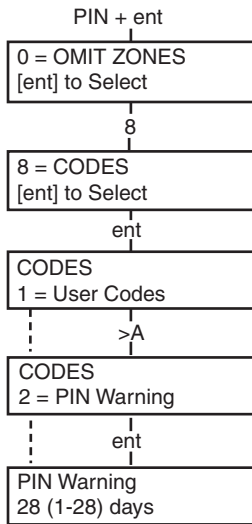

### Pin Warning

This option determines the number of days notification before the expiry date of any user codes programmed as **PIN Change**. During the notification period, the user is prompted to enter a new code on entry of the expiring PIN. The default period is **99** days, with a programmable range of **1 – 99**. If a user does not assign a new code by the end of the **PIN Warning** period, then the code is erased on the next unsetting of the system.

**Note:** The **PIN Warning** ends on the last day of the month, the PIN expires on the first day of the following month.

### Summer (User Type 3.6)

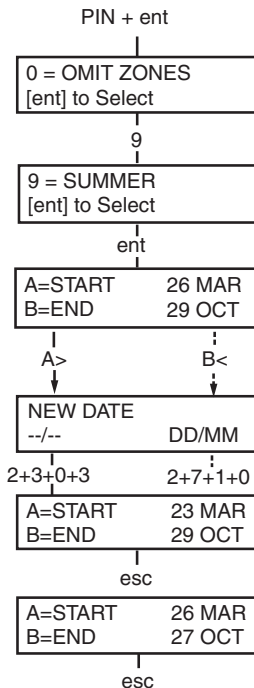

On the first day of each year, the British Summer Time (**BST**) **Start** date is set to the last Sunday in March and the **End** date is set to the last Sunday in October.

The operation of the **Summer** option is as follows: At 01 : 00 hours on the **Start** date, the system clock advances to 02 : 00 hours. At 02 : 00 hours on the **End** date, the system clock goes back to 01 : 00 hours .

**Note:**The time always changes with reference to GMT.  
For example, Italy which is + 1 hour would be:

Last Sunday in March - 02.00 to 03.00  
Last Sunday in October - 03.00 to 02.00

The **Start** and **End** dates can be reprogrammed by authorised user codes. Press the **A>** key to modify the **Start** date or the **<B** key to select the **End** date. The new date must be a valid four digit number in the day month format (dd/mm).

## Trace (User Type 3.6)

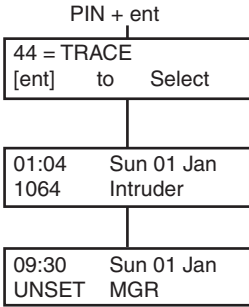

This option provides a record of the most recent alarm activation. The **Trace** option records the details of the setting and unsetting of the system immediately before and after the alarm activation and the first 5 events occurring during the alarm activation. This information is maintained in the trace until the next alarm activation. On entering the option pressing the **A** and **B** keys steps through each of the 7 trace entries.

Pressing the # key while viewing the **Trace** option displays additional information about certain events — user events reveal the keypad, user level and current group; alarm events reveal the zone descriptor if programmed.

The current display trace can be printed out by pressing the \* key; pressing the **esc** key aborts the print-out.

## Timer Control (User Type 3.6)

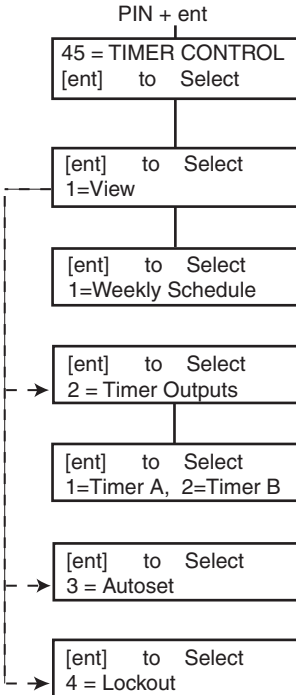

### 1=View

This function allows the weekly schedules, programmed by the engineer, to be viewed:

### 1 = Weekly Schedule

Use the **A** and **B** keys to scroll through the programmed on/off times.

### 2 = Timer Outputs

This option shows the **Timer-A** and **Timer-B** outputs with on/off times.

### 3 = Autotest

Use the **A** and **B** keys to scroll through the groups to select one (optional) and also to view the time schedule allocated per group.

### 4 = Lockout

Use the **A** and **B** keys to scroll through the groups to select one (optional) and also to view the time schedule allocated per group.

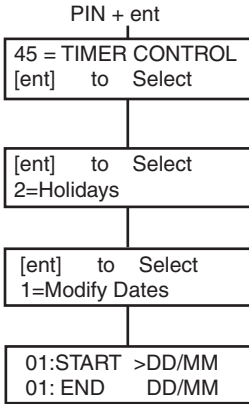

## 2=Holidays

This function allows up to 32 holiday periods to be allocated. A **Start** and **End** date is entered for each holiday period using the **1=Modify Dates** option. On selecting this option, the **Start** and **End** dates for holiday period **01** are displayed. If no dates have been entered for this period, then the display will show **\*\*/\*\***. To program the **Start** date, press the **ent** key; the date display changes to **>DD/MM<**; enter a valid 4 digit number and press the **ent** key to accept the selection. The year is not required, only the day and month.

Press the **#** key to move to the **End** date and follow the procedure for programming the **Start** date.

To remove a programmed date, press the **\*** key. The date display returns to **\*\*/\*\***.

**NOTE:** The holiday periods can only be programmed by managers and engineers

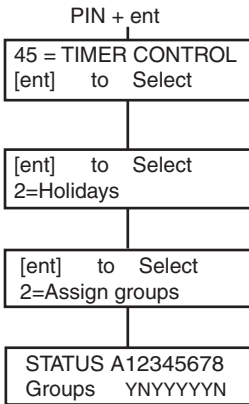

The groups that are affected by the programmed holiday period are assigned using the **2=Assign groups** function.

On selecting the **Assign Groups** option, the groups currently assigned to the programmed holiday periods are indicated by a **Y** below the group; an **N** is displayed below the unassigned groups. All groups default to **Y**. Pressing the group number toggles the group status. When the required groups have been assigned to the holidays, press the **ent** key to accept the programming and return to the previous menu level.

**NOTE:** The larger Galaxy systems have more than 8 groups; these are displayed on the keypad in blocks of eight groups. Press **A** or **B** keys to display each of the group blocks.

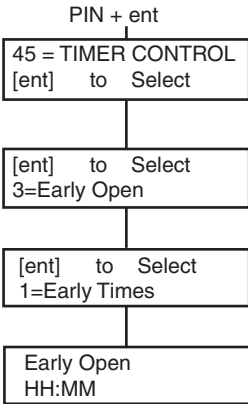

### 3=Early Open

If the **Early Open** option (45.3.2) is enabled, the **Lockout OFF** time for the following day is brought forward by the number of minutes (0 – 240) programmed by the engineer. This allows the system to be manually unset earlier than normal. There are 2 functions within this option:

The **1=Early Times** function displays the time that the system can be manually unset on the following day; this time is the **Lockout OFF Time** minus the **Early Open** period and is displayed in the 24 hour format.

If groups have been enabled, the early opening time for each of the groups enabled for early opening in the **Early Open** option can be viewed by pressing the **A** or **B** keys

This function only displays the early time if the **Early Open** option is enabled; if this option is disabled or if no groups have been enabled, the message **NO ENTRIES** is displayed.

The **2=Early Open** function permits early opening to be disabled or enabled.

If groups have been enabled, then the groups can be individually enabled to permit early opening.

### 4=Timers

This option allows each of the programmed weekly timer schedules to be switched on and off as required. If a timer schedule is set to off, the operation of the **timer** is suspended; this option cannot be used to alter the programmed times. All timer schedules default to **0 = Off**. To switch the timer schedule on, select the required timer and change the setting to **1=On**.

## 5=Late Work

The **Late Work** option authorises an **Autoset Extension** in advance of the prewarning period.

## 6=Weekend Work

The **Weekend Work** option unsets the system at the weekend. If the **Weekend Day** is programmed other than **0 = OFF** (default), on the next occurrence of the programmed **Weekend Day**, the **Timers** adopt the times they have on the assigned **Pattern day**. For example, this allows a Sunday to use the Autoset and Lockout Timers of a Monday.

**NOTE:** Parameter **41 = Weekend Work** must be enabled (default is **Disabled**) to allow the **Weekend Day** to be selected by the user.

On selecting the **1=Weekend Day** option the programmed **Weekend Day** is displayed; the default is **0 = OFF**. Use the **A** or **B** keys to select the required day or days and press the **ent** key to accept the programming and return to the previous menu level:

- |          |   |                                   |
|----------|---|-----------------------------------|
| <b>0</b> | = | <b>OFF</b>                        |
| <b>1</b> | = | <b>SAT</b>                        |
| <b>2</b> | = | <b>SUN</b>                        |
| <b>3</b> | = | <b>BOTH</b> (Saturday and Sunday) |

The selected **Weekend Day** remains active for one occurrence only. The **Weekend Day** returns to the default of **OFF** immediately following the assigned day. The **Weekend Day** must be allocated each time the function is required.

On selecting the **2=Pattern Day** option the user is shown the programmed timers that are effective when the **Weekend Day** option is selected. The timers of the selected **Pattern Day (Mon to Fri)** are adopted by the days selected for the weekend work.

**NOTE:** The **Pattern Day** can only be allocated by the engineer.

## 7 = Access Template

This option shows a template of the weekly time schedules for each user on the system. There are two options:

### 1 = Name

A template name for a user of up to 12 characters can be entered here.

### 2 = Schedule

The schedules programmed in Menu option 65, Timers, are allocated to each group with the selected access template under this option. Group mode has to be enabled in menu option 63.1 to allocate a weekly schedule to a group.

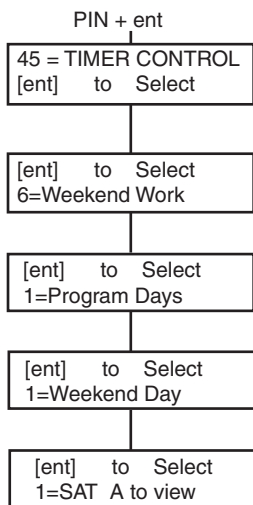

## Group Omit (User Type 3.6)

This option allows a type 3.6 type code to block omit all the omissible zones that are open at the end of the confirm time in a group or multiple groups. All zones in the required groups that have the omit attribute enabled are omitted when this option is selected. Groups can be omitted and reinstated without setting and unsetting the system.

On selecting the **Group Omit** Option the groups assigned to the user code and keypad are displayed as well as the omit status of each group (**Y** below the group indicates that it is omitted, **N** indicates that it is not omitted). To omit a group, press the required key. The letter beneath the group number changes from **N** to **Y**. To reinstate the group press the key to toggle from **Y** to **N**.

**NOTE:** The type 3.6 user must have group choice to enter **Group Omit**.

**NOTE:** The zones in the selected groups are omitted from the system as soon as the group is selected.

On returning to the banner the keypad displays the message **ZONES OMITTED**. Omitted zones remain omitted for one set period only or until they are manually reinstated to the system.



## Remote Access (User Type 3.6)

This menu option allows control of remote servicing connections. Remote servicing is a procedure which allows the installer to service the alarm system remotely via a phone line or similar connection.

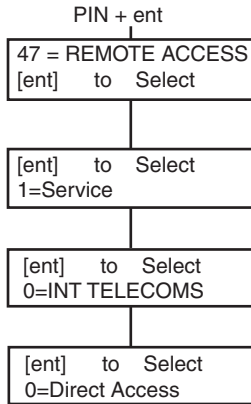

The **1=Service** option enables the user to control the access mode of the remote servicing package. There are 4 communication devices available.

- 0=INT TELECOMS**
- 1=ISDN**
- 2=ETHERNET**
- 3=EXT TELECOMS**

Choose the appropriate device as per the system setup. The user has 2 further options to choose from:

**0=Direct Access** - On selecting this option, a 40 minute access period is enabled on the Galaxy panel; remote servicing software can directly access the system during this period. Once access to the panel has been gained, it can be maintained indefinitely; there is no maximum duration. On terminating the remote servicing connection to the panel, the access period remains valid for an additional 15 minutes.

### 1=Call back-1-5

When the user selects one of the numbers (1 – 5) followed by the **ent** key, the Galaxy panel dials out to the preprogrammed telephone number associated with the **Call Back** number.

If the number selected does not have a preprogrammed telephone number, the system prompts for a number **1** to be entered. Enter the required telephone number and press the **ent** key; the panel then dials out to the telephone number entered.

**NOTE:** The PC that the panel is dialling to **must** have remote servicing software running in the **Waiting for Call-Back** mode.

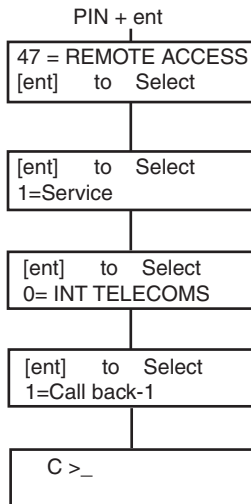

## **Access Authorization (User Type 3.6)**

To allow the engineer to gain access to the system, the engineer's code must be authorised using this menu. When menu 48.1.1 is set to 1 = enabled, the engineer's code will be activated.

The manager's code should be enabled at all times via menu 48.1.2.

# AVOIDING FALSE ALARMS

False alarms are inconvenient and may be costly. Police can withhold response from consistent offenders.

## **Here are nine points to help avoid false alarms.**

1. Be sure you fully understand how to operate the alarm system. In your absence someone thoroughly instructed, should be available to operate the system.
2. Before leaving the premises ensure that all doors and windows are securely closed.
3. Where passive infra red or movement detectors are installed make sure the areas are kept free from all animals or birds. Particular attention should be paid to swinging signs, fluorescent lights, Christmas decorations, electric fans, heating or ventilating systems. These should be switched off if possible
4. Always follow the exit/entry route procedure agreed with your alarm installer.
5. Treat the alarm components with care to ensure they are not damaged.
6. Consult your alarm installer about changes to your building and its contents if you think they may affect the alarm system or its performance.
7. Always report alarm activation to your alarm installer. If necessary, an engineer will be sent to check the system.
8. If opening or closing times are monitored by a central station be sure you notify them of any variations from the agreed times or password.
9. The system should be fitted with a stand-by battery (not included) which will operate the system for a limited period in the event of a mains failure. Please ensure that the mains is restored as quickly as possible so that the stand-by battery can be recharged.

# ZONE REFERENCE TABLES

Zone	Function	Description	Chime	Omit	Part
1001					
1002					
1003					
1004					
1005					
1006					
1007					
1008					
1011					
1012					
1013					
1014					
1015					
1016					
1017					
1018					

RIO	Zone	Function	Description	Chime	Omit	Part
	1					
	2					
	3					
	4					
	5					
	6					
	7					
	8					

RIO	Zone	Function	Description	Chime	Omit	Part
	1					
	2					
	3					
	4					
	5					
	6					
	7					
	8					

# ALARM AND HELP MESSAGES

ALARM IN  
PROGRESS

## Alarm In Progress

The system is currently in alarm condition and must be cancelled by a valid PIN or keyswitch operation.

PA  
RESET REQUIRED

## Pa Reset Required

After a PA (Personal Attack) zone has been activated, the system has to be reset by a high level code (such as a manager or engineer depending on the reset level setting).

CALL MANAGER  
RESET REQUIRED

## Manager Reset Required

Following an alarm activation, the system requires to be reset by a manager level code. This message is displayed when a tamper alarm occurs.

CALL ENGINEER  
RESET REQUIRED

## Engineer Reset Required

The system has been programmed for engineer reset following an alarm activation. The engineer must be called to reset the system before the user can set the alarm. Tamper alarms usually require an engineer to visit the site to check all modules on the system.

ALARM CAUSE CODE  
>

## Alarm Cause Code

Following an alarm activation, the system requires to be reset by user entry of an appropriate alarm cause code.

NO ENTRIES

## No Entries

This message appears if a user attempts to view or inspect the log and there is nothing in the log to be viewed or when the omit option is selected and there are no omittable zones on the system.

INVALID  
OPTION

## Invalid Selection

The option selected or value entered is illegal or out of range.

INVALID CODE

## Invalid Code

The code entered is not a valid code registered in the system memory.

OPTION NOT  
AVAILABLE

## Option Not Available

This option is provided by the engineer, where it is specifically required. Attempting to select an option when it has not been provided results in the display of

CALL ALARM CO.  
QUOTE CODE XXXXX

## Technistore Reset

Call the Alarm Monitoring Station and quote the five digit number displayed. Enter the number quoted by the monitoring station to reset the system.

NO MODULE ADDED  
ESC TO CONTINUE

## No Modules Added

When exiting Engineer Mode the panel does not detect the change in the number of modules. Press **esc** to continue.

# INSTALLER DETAILS

Name: -----

Address: -----

-----

-----

-----

Telephone: -----

Office Hours: -----

Other Times: -----

Account No.: -----



